

Welcome to the world of KitchenAid®

We're committed to helping you create a lifetime of delicious meals for family and friends. To help ensure the longevity and performance of your appliance, keep this guide handy.

It will empower you with the best way to use and care for your product. Your satisfaction is our #1 goal. Remember to register your product online at www.kitchenaid.com, or by mail using the attached Product Registration Card.



USA: 1.800.541.6390
Canada: 1.800.807.6777
KitchenAid.com
KitchenAid.ca

Table of Contents

FOOD PROCESSOR SAFETY	
Important Safeguards.....	4
Electrical Requirements.....	5
PARTS AND FEATURES.....	6
ACCESSORIES	
Included Accessories.....	7
Accessories Selection Guide.....	8
PREPARING THE FOOD PROCESSOR FOR FIRST USE	9
SETTING UP YOUR FOOD PROCESSOR	
Attaching the Work Bowl.....	10
Attaching the Work Bowl Cover.....	10
Installing the Adjustable Slicing Disc.....	11
Installing the Reversible Shredding Disc.....	11
Installing the Multipurpose Blade.....	12
Using the 2-in-1 Feed Tube.....	12
USING YOUR FOOD PROCESSOR	
Before Use.....	13
Maximum Liquid Level.....	13
Using the Low/High Speed Control.....	13
Using the Pulse Control.....	13
Removing Processed Foods.....	14
CLEANING THE FOOD PROCESSOR.....	15
FOOD PROCESSING TIPS	
Tips for Great Results.....	16
Helpful Hints.....	18
TROUBLESHOOTING	19
WARRANTY.....	20

Find recipes and more at
www.kitchenaid.com

Your safety and the safety of others are very important.

We have provided many important safety messages in this manual and on your appliance. Always read and obey all safety messages.



This is the safety alert symbol.

This symbol alerts you to potential hazards that can kill or hurt you and others.

All safety messages will follow the safety alert symbol and either the word "DANGER" or "WARNING." These words mean:

! DANGER

You can be killed or seriously injured if you don't immediately follow instructions.

! WARNING

You can be killed or seriously injured if you don't follow instructions.

All safety messages will tell you what the potential hazard is, tell you how to reduce the chance of injury, and tell you what can happen if the instructions are not followed.

IMPORTANT SAFEGUARDS

When using electrical appliances, basic safety precautions should always be followed, including the following:

1. Read all instructions.
2. To protect against risk of electrical shock, do not put Food Processor in water or other liquid.
3. Close supervision is necessary when any appliance is used by or near children.
4. Unplug from the outlet when not in use, before putting on or taking off parts, and before cleaning.
5. Avoid contacting moving parts.
6. Do not operate any appliance with a damaged cord or plug, or after the appliance malfunctions, or is dropped or damaged in any manner. Return appliance to the nearest Authorized Service Facility for examination, repair, or electrical or mechanical adjustment.
7. The use of attachments not recommended or sold by KitchenAid may cause fire, electric shock, or injury.
8. Do not use outdoors.
9. Do not let cord hang over edge of table or counter.
10. Keep hands and utensils away from moving blades or discs while processing food to reduce the risk of severe injury to persons or damage to the Food Processor. A scraper may be used but must be used only when the Food Processor is not running.
11. Blades are sharp. Handle carefully.
12. To reduce the risk of injury, never place cutting blade or discs on base without first putting bowl properly in place.
13. Be certain cover is securely locked in place before operating appliance.
14. Never feed food by hand. Always use the food pusher.
15. Do not attempt to defeat the cover interlock mechanism.
16. This product is designed for household use only.

SAVE THESE INSTRUCTIONS

Electrical Requirements

Volts: 120 V.A.C.

Hertz: 60 Hz

NOTE: This Food Processor is equipped with a polarized plug (one blade is wider than the other). To reduce the risk of electrical shock, this plug will fit in a polarized outlet only one way. If the plug does not fit fully in the outlet, reverse the plug. If it still does not fit, contact a qualified electrician. Do not modify the plug in any way.

Proof of Purchase & Product Registration

Always keep a copy of the itemized sales receipt showing the date of purchase of your Food Processor. Proof of purchase will assure you of in-warranty service. Before you use your Food Processor, please fill out and mail your product registration card packed with the unit. This card will enable us to contact you in the unlikely event of a product safety notification and assist us in complying with the provisions of the Consumer Product Safety Act. This card does not verify your warranty. Please complete the following for your personal records:

Model Number _____

Serial Number _____

Date Purchased _____

Store Name _____

Parts and Features

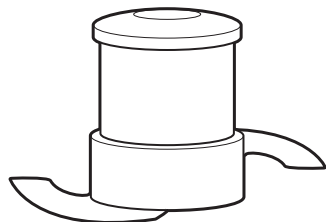

**Multipurpose
Stainless Steel
Blade**

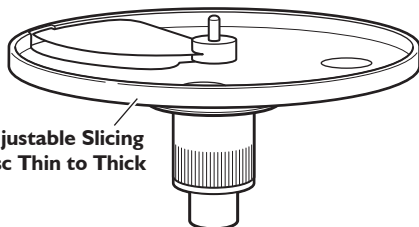

**Adjustable Slicing
Disc Thin to Thick**

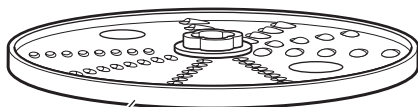

**Reversible
(2 mm and 4 mm)
Shredding Disc**

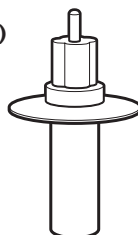

**Shredding
Adapter**

**2-Piece
Food Pusher**

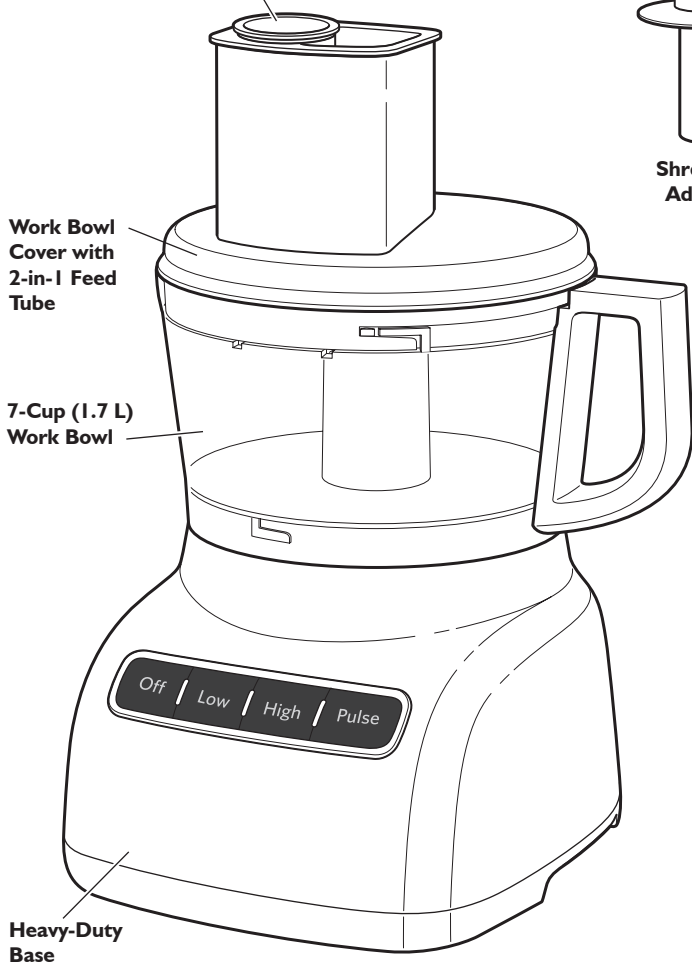

**Work Bowl
Cover with
2-in-1 Feed
Tube**

**7-Cup (1.7 L)
Work Bowl**

**Heavy-Duty
Base**

Off | Low | High | Pulse

Parts and Features

Important parts and accessories included with your new Food Processor are highlighted below. Refer to the following pages for additional details on accessories included with your Food Processor.

Adjustable Slicing

KitchenAid's® adjustable slicing disc allows you to manually adjust slicing thickness from thin to thick.

High/Low/Pulse/Control

Two speeds and Pulse provide precise control to give great results with most any food.

Work Bowl Cover with 2-in-1 Feed Tube (KFP07LSFT)

One of the industry's largest, the 2-in-1 feed tube accommodates large items such as tomatoes, cucumbers, and potatoes with a minimum of sectioning or slicing.

2-Piece Food Pusher (KFP07FTP)

The 2-Piece food pusher allows you to select a large feed tube opening for continuous processing, or a smaller opening depending on the task.

For continuous processing of smaller items (like herbs, nuts, single carrots, and celery), remove the narrow pusher and use the narrow feed tube.

A small hole in the bottom of the narrow pusher makes it easy to drizzle oil into ingredients – just fill with the desired amount of oil or other liquid ingredient.

Heavy-Duty Base

The heavy, slip-resistant base helps provide improved stability and reduced vibration during tough food processing jobs.

Accessories

Included Accessories

7-Cup (2.0 L) Work Bowl (KFP07WBOB)

The durable, large work bowl provides capacity for large jobs.

Adjustable Slicing Disc (KFP07ASL)

Disc is adjustable from approximately $\frac{1}{16}$ inch (1 mm) to $\frac{1}{4}$ inch (6 mm) for slicing most foods.

Reversible Shredding Disc (KFP07RD)

Shredding disc is reversible to allow coarse or finely shredded cheese or vegetables.















Drive Adapter

The drive adapter is used to connect the slicing/shredding disc to the power shaft on the base.

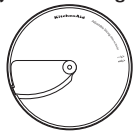
Multipurpose Blade (KFP07BL)

Versatile blade chops, minces, blends, mixes, and emulsifies in a matter of seconds.

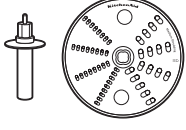
Accessories Selection Guide

Action	Setting	Food	Accessory
 Chop		Cheese Chocolate Fruit Fresh herbs Nuts Tofu Vegetables	Multipurpose Blade 
 Mince		Pasta Sauce Pesto Salsa Sauces	
 Mix			
 Slice Thin		Fruit (soft) Potatoes Tomatoes Vegetables (soft)	Adjustable Slicing Disc 
 Slice Thick		Cheese Chocolate Fruit (hard) Vegetables (hard)	
 Shred Medium		Potatoes Vegetables (soft)	Reversible Shredding Disc 
 Shred Fine		Cabbage Cheese Chocolate Fruit (hard) Vegetables (hard)	

⚠ WARNING

Cut Hazard

Handle blades carefully.

Failure to do so can result in cuts.

Before First Use

Before using your Food Processor for the first time, wash all parts and accessories either by hand or in the dishwasher (see “Cleaning the Food Processor” section).

Removing the Work Bowl Cover from the Work Bowl

Your Food Processor is shipped with the work bowl cover installed on the work bowl.

To remove the work bowl cover from the work bowl for initial cleaning:

1. Grasp the feed tube on the work bowl cover and turn it clockwise to remove it from the work bowl.

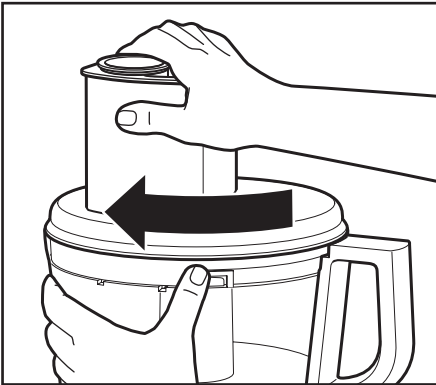

Setting Up Your Food Processor

Attaching the Work Bowl

1. Place the Food Processor on a dry, level countertop with the controls facing forward. Do not plug in the Food Processor until it is completely assembled.
2. Place the work bowl on the base, aligning the raised portion with the indentation on the base. The center hole should fit over the power shaft.

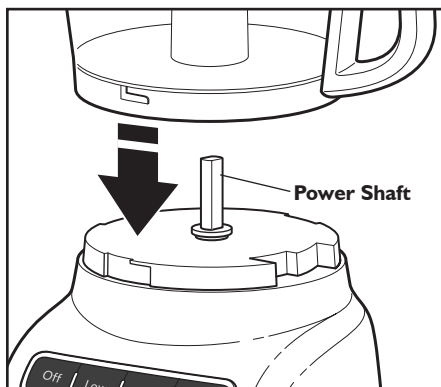

3. Grasp the work bowl handle and turn the bowl counterclockwise to lock it on the base.

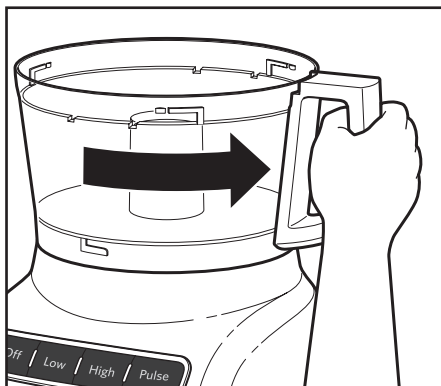

4. Select the accessory you would like to use and install it according to the instructions on the following pages.

NOTE: Be sure to install the desired accessory before attaching the work bowl cover.

Attaching the Work Bowl Cover

1. Place the work bowl cover on the work bowl with the feed tube just to the left of the work bowl handle. Grasp the feed tube and turn the cover to the right until it locks into place.

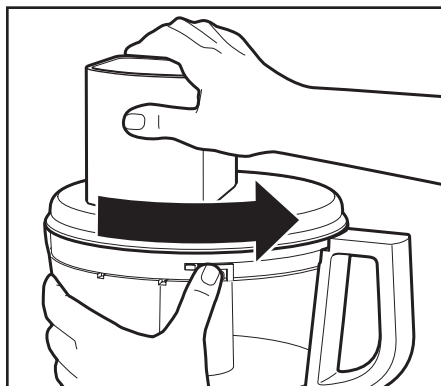

2. Fit the food pusher into the 2-in-1 feed tube. See "Using the 2-in-1 Feed Tube" section for details on working with different sized foods.

NOTE: Your Food Processor will not operate unless the work bowl and work bowl cover are properly locked on the base.

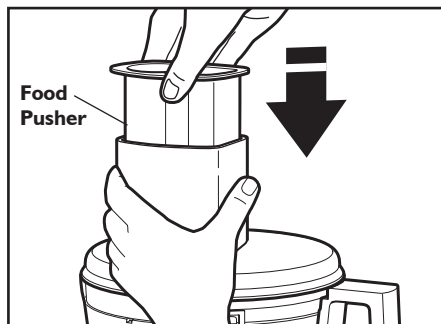

NOTE: Be sure to install the desired accessory before attaching the work bowl cover.

! WARNING

Cut Hazard

Handle blades carefully.

Failure to do so can result in cuts.

Installing the Adjustable Slicing Disc

The Adjustable Slicing Disc is easily adjusted and makes slicing tasks simple. Follow these steps for adjusting and installing the Adjustable Slicing Disc.

1. Holding the slicing disc, twist the ridged portion of the shaft clockwise for thinner slices, or counterclockwise for thicker slices.

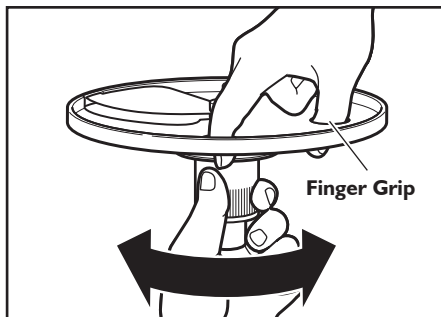

2. With the work bowl installed, hold the slicing disk by the finger grips and lower it onto the drive adapter.

TIP: You may need to turn the disc/drive adapter until it drops down into place.

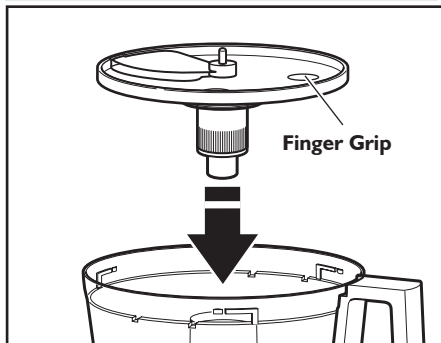

3. Install the work bowl cover, being sure it locks into place.

Installing the Reversible Shredding Disc

1. Holding the reversible shredding disc by the 2 finger grips, insert the shredding adapter into the hole in the bottom of the disc.

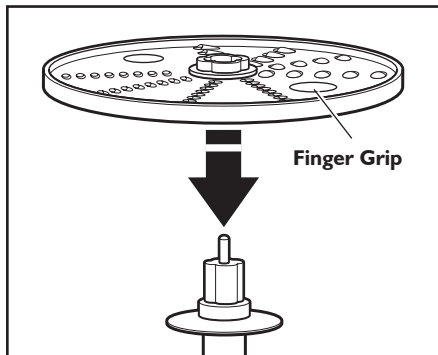

2. With the work bowl installed, slide the drive adapter onto the power shaft.

TIP: You may need to turn the disc/adapter until it drops down into place.

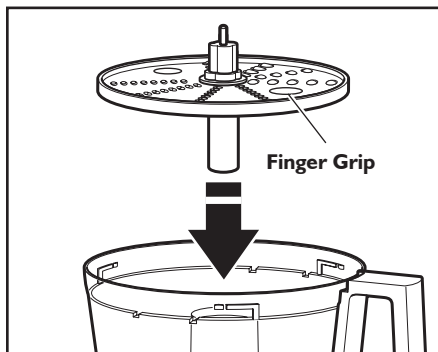

3. Install the work bowl cover, being sure it locks into place.

Setting Up Your Food Processor

Installing the Multipurpose Blade

1. Place the blade on the power shaft.
2. Rotate the blade so it falls into place on the power shaft.

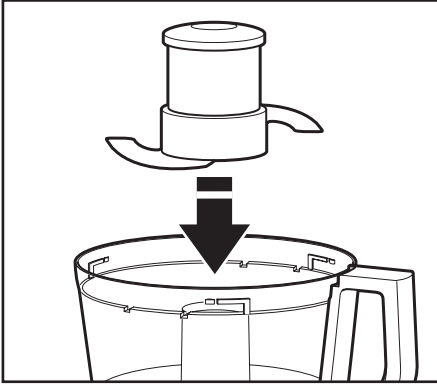

3. Push to lock: Press down firmly on the multipurpose blade until it is down as far as it will go. The multipurpose blade features an internal seal that fits tightly over the center of the work bowl.

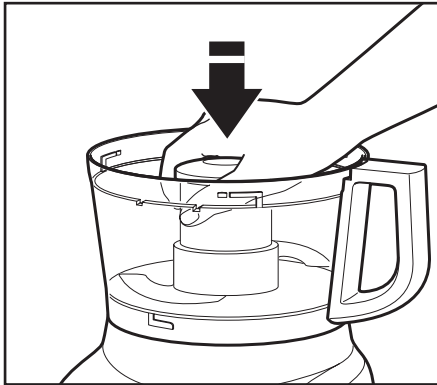

4. Install the work bowl cover, being sure it locks into place. See "Attaching the Work Bowl Cover" section.

Using the 2-in-1 Feed Tube

The 2-in-1 feed tube features a 2-piece food pusher. To slice or shred small items, insert the 2-piece food pusher into the feed tube.

Use the small feed tube and pusher to process small or slender items, like single carrots or celery stalks.

To slowly drizzle oil into ingredients, just fill the small pusher with the desired amount of oil.

A small hole in the bottom of the pusher will drizzle the oil at a constant rate.

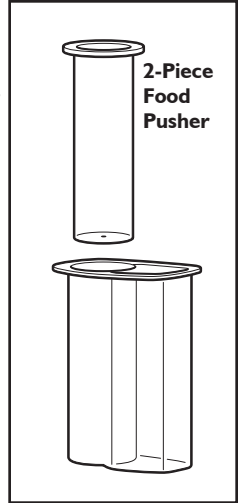

⚠️ WARNING



Rotating Blade Hazard

Always use food pusher.

Keep fingers out of openings.

Keep away from children.

Failure to do so can result in amputation or cuts.

Using the Low/High Speed Control

1. To turn on the Food Processor, press the Low or High button. The Food Processor will run continuously and the indicator light will glow.
2. To stop the Food Processor, press the OFF button. The indicator light will go out and the blade or disc will stop within a few seconds.
3. Wait until the blade or disc comes to a complete stop before removing the work bowl cover. Be sure to turn off the Food Processor before removing the work bowl cover, or before unplugging the Food Processor.

NOTE: If the Food Processor fails to operate, make sure the work bowl and cover are properly locked on the base (see “Setting Up Your Food Processor”).

Using the Pulse Control

The pulse control allows precise control of the duration and frequency of processing. It's great for jobs which require a light touch. Just press and hold the PULSE Button to start processing at high speed, and release it to stop.

Before Use

Before operating the Food Processor, be sure the work bowl, blades, and work bowl cover are properly assembled on the Food Processor base (see “Setting Up Your Food Processor”).

Maximum Liquid Level

This line on the work bowl indicates the maximum level of liquid that can be processed by the Food Processor.

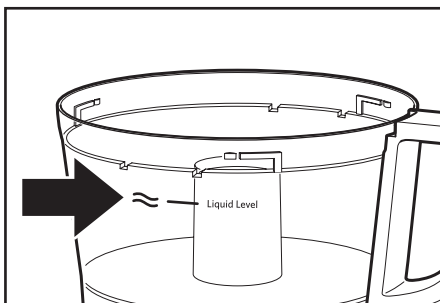

Using Your Food Processor

! WARNING

Cut Hazard
Handle blades carefully.
Failure to do so can result in cuts.

Removing Processed Foods

1. Press the OFF Button.
2. Unplug the Food Processor before disassembling.
3. Turn the work bowl cover to the left and remove.

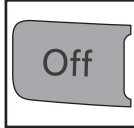

5. Turn the work bowl to the left to unlock it from the base. Lift to remove.

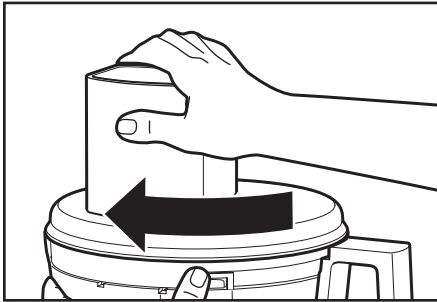
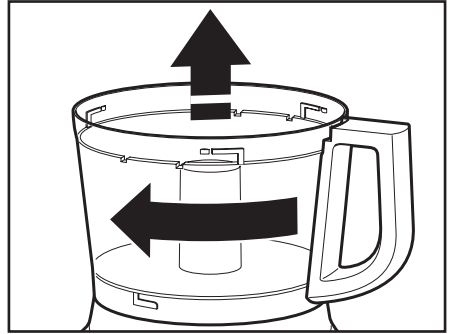

4. If using a disc, remove it before removing the bowl. Holding the disc by the 2 finger grips, lift it straight up. Remove the adapter when using the Shredding Disc.

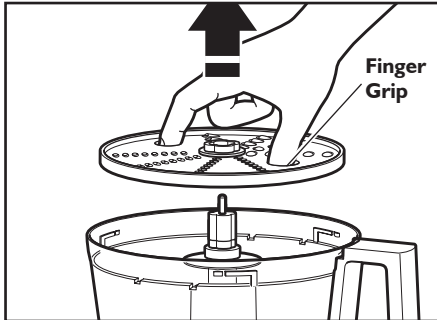
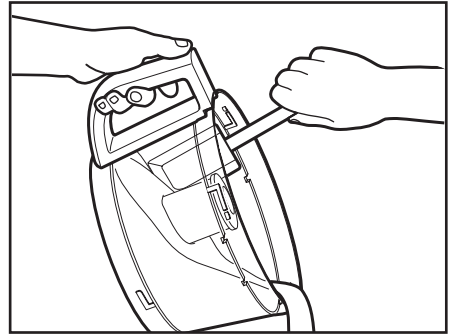

6. The multipurpose blade can be removed from the work bowl before the contents are emptied. You may also leave the blade locked in place. Then remove food from the bowl and blade with a spatula.

⚠️ WARNING

Cut Hazard

Handle blades carefully.

Failure to do so can result in cuts.

1. Press the OFF Button.
2. Unplug the Food Processor before cleaning.
3. Wipe the base and cord with a warm, sudsy cloth, and wipe clean with a damp cloth. Dry with a soft cloth. Do not use abrasive cleansers or scouring pads.
4. Please note these BPA-free bowls require special handling. If you choose to use a dishwasher instead of hand washing, please follow these guidelines.
 - All parts are top rack dishwasher safe.
 - Avoid laying the bowl on its side.
 - Use gentle dishwashing cycles such as Normal. Avoid high temperature cycles such as Sanitize, Steam, and Pot Scrubbing.
5. If washing the Food Processor parts by hand, avoid the use of abrasive cleansers or scouring pads. They may scratch or cloud the work bowl and cover. Thoroughly dry all parts after washing.

6. To prevent damage to the locking system, always store the work bowl and work bowl cover in the unlocked position when not in use.



7. Wrap the power cord around the work bowl. Secure the plug by clipping it to the cord.

Tips for Great Results

⚠ WARNING

Cut Hazard

Handle blades carefully.

Failure to do so can result in cuts.

Using the Multipurpose Blade



To chop fresh fruits or vegetables:

Peel, core, and/or remove seeds. Cut food in 1 to 1½-inch (2.5-3.75 cm) pieces. Process

food to desired size, using short pulses, 1 to 2 seconds each time. Scrape sides of bowl, if necessary.

To puree cooked fruits and vegetables (except potatoes):

Add ¼ cup (60 ml) liquid from recipe per cup (235 ml) of food. Process food, using short pulses, until finely chopped. Then process continuously until reaching desired texture. Scrape sides of bowl, if necessary.

To prepare mashed potatoes:

Shred hot cooked potatoes using the shredding disc. Exchange shredding disc for multipurpose blade. Add softened butter, milk, and seasonings. Pulse 3 to 4 times, 2 to 3 seconds each time, until smooth and milk is absorbed. Do not over process.

To chop dried (or sticky) fruits:

The food should be cold. Add ¼ cup (60 ml) flour from recipe per ½ cup (120 ml) dried fruit. Process fruit, using short pulses, until reaching desired texture.

To finely chop citrus peel:

With sharp knife, peel colored portion (without white membrane) from citrus. Cut peel in small strips. Process until finely chopped.

To mince garlic or to chop fresh herbs or small quantities of vegetables:

With processor running, add food through the feed tube. Process until chopped. For best results, make sure work bowl and herbs are very dry before chopping.

To chop nuts or make nut butters:

Process up to 3 cups (710 ml) of nuts to desired texture, using short pulses, 1 to 2 seconds each time. For a coarser texture, process smaller batches, pulsing 1 or 2 times, 1 to 2 seconds each time. Pulse more often for finer texture. For nut butters, process continuously until smooth. Store in refrigerator.

NOTE: Processing nuts and other hard foods may scratch the surface finish on the inside of the bowl.

To chop cooked or raw meat, poultry or seafood:

The food should be very cold. Cut in 1-inch (2.5 cm) pieces. Process up to 1 pound (455 g) at a time to desired size, using short pulses, 1 to 2 seconds each time. Scrape sides of bowl, if necessary.

To make bread, cookie, or cracker crumbs:

Break food into 1½ to 2-inch (3.75-5 cm) pieces. Process until fine. For larger pieces, pulse 2 to 3 times, 1 to 2 seconds each time. Then process until fine.

To melt chocolate in a recipe:

Combine chocolate and sugar from recipe in work bowl. Process until finely chopped. Heat liquid from recipe. With processor running, pour hot liquid through the feed tube. Process until smooth.

To grate hard cheeses, such as Parmesan and Romano:

Never attempt to process cheese that cannot be pierced with the tip of a sharp knife. You can use the multi-purpose blade to grate hard cheeses. Cut cheese in 1-inch (2.5 cm) pieces. Place in work bowl. Process, using short pulses, until coarsely chopped. Process continuously until finely grated. Pieces of cheese can also be added through the feed tube while the processor is running.

Food Processing Tips

Using a Slicing or Shredding Disc

! WARNING



Rotating Blade Hazard

Always use food pusher.

Keep fingers out of openings.

Keep away from children.

Failure to do so can result in amputation or cuts.



To slice or shred fruits or vegetables that are long and relatively small in diameter, such as celery, carrots, and bananas:

Cut food to fit feed tube vertically or horizontally, and pack feed tube securely to keep food positioned properly. Process using even pressure with the food pusher. Or use the small feed tube in the two-piece food pusher. Position food vertically in the tube and use the small food pusher to process food.

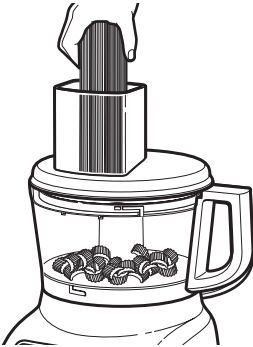

To slice or shred fruits and vegetables that are round, such as onions, apples, and green peppers:

Peel, core, and remove seeds. Cut in halves or quarters to fit feed tube. Position in feed tube. Process using even pressure with the food pusher.

To slice or shred fruits and vegetables that are small, such as strawberries, mushrooms, and radishes:

Position food vertically or horizontally in layers within the feed tube. Fill feed tube in order to keep food positioned properly. Process using even pressure with the food pusher. Or use the small feed tube in the two-piece food pusher. Position food vertically in the tube and use the small food pusher to process food.

To slice uncooked meat or poultry, such as stir-fry meats:

Cut or roll food to fit feed tube. Wrap and freeze food until hard to the touch, 30 minutes to 2 hours, depending on thickness of food. Check to be sure you can still pierce food with the tip of a sharp knife. If not, allow to thaw slightly. Process using even pressure with the food pusher.

To slice cooked meat or poultry, including salami, pepperoni, etc.:

Food should be very cold. Cut in pieces to fit feed tube. Process food using firm, even pressure with the food pusher.

To shred spinach and other leaves:

Stack leaves. Roll up and stand up in feed tube. Process using even pressure with the food pusher.



To shred firm and soft cheeses:

Firm cheese should be very cold. For best results with soft cheeses, such as mozzarella, freeze 10 to 15 minutes before processing. Cut to fit feed tube. Process using even pressure with the food pusher.

Food Processing Tips

Helpful Hints

- To avoid damage to the blade or motor, do not process food that is so hard or firmly frozen that it cannot be pierced with the tip of a sharp knife. If a piece of hard food, such as a carrot, becomes wedged or stuck on the blade, stop the processor and remove the blade. Gently remove food from the blade.
- Do not overfill work bowl. For thin mixtures, fill work bowl up to 1/2 to 2/3 full. For thicker mixtures, fill work bowl up to 3/4 full. For liquids, fill up to the maximum level as described in the "Using Your Food Processor" section of this book. When chopping, the work bowl should be no more than 1/3 to 1/2 full.
- Position slicing discs so the cutting surface is just to the right of the feed tube. This allows the blade a full rotation before contacting the food.
- To capitalize on the speed of the processor, drop ingredients to be chopped through the feed tube while the processor is running.
- Soft and medium-hard cheese may spread out or roll up on the shredding disc. To avoid this, shred only well-chilled cheese.
- Sometimes slender foods, such as carrots or celery, fall over in the feed tube, resulting in an uneven slice. To minimize this, cut food in several pieces and pack the feed tube with the food. For processing small or slender items, the small feed tube in the two piece food pusher will prove especially convenient.



- Different foods require varying degrees of pressure for best shredding and slicing results. In general, use light pressure for soft, delicate foods (strawberries, tomatoes, etc.), moderate pressure for medium foods (zucchini, potatoes, etc.), and firmer pressure for harder foods (carrots, apples, hard cheeses, partially frozen meats, etc.).
- When preparing a cake or cookie batter or quick bread, use the multipurpose blade to cream fat and sugar first. Add dry ingredients last. Place nuts and fruit on top of flour mixture to prevent over chopping. Process nuts and fruits, using short pulses, until blended with other ingredients. Do not over process.
- When shredded or sliced food piles up on one side of the bowl, stop the processor and redistribute the food using a spatula.
- When food quantity reaches the bottom of a slicing or shredding disc, remove the food.
- A few larger pieces of food may remain on top of the disc after slicing or shredding. If desired, cut these by hand and add to mixture.
- Organize processing tasks to minimize bowl cleanup. Process dry or firm ingredients before liquid ingredients.
- To clean ingredients from the multipurpose blade easily, just empty the work bowl, replace the lid, and pulse 1 to 2 seconds to spin the blade clean.
- After removing the work bowl cover, place it upside down on the counter. This will help keep the counter clean.
- Your Food Processor is not designed to perform the following functions:
 - Grind coffee beans, grains, or hard spices
 - Grind bones or other inedible parts of food
 - Liquefy raw fruits or vegetables
 - Slice hard-cooked eggs or unchilled meats.
- If any plastic parts should discolor due to the types of food processed, clean them with lemon juice

If your Food Processor should malfunction or fail to operate, check the following:

Food Processor doesn't run:

- Make sure that the bowl and lid are properly aligned and locked in place.
- Press only one button at a time. The Food Processor will not operate if more than one button is pressed at the same time.
- Is the Food Processor plugged in?
- Is the fuse in the circuit to the Food Processor in working order? If you have a circuit breaker box, be sure the circuit is closed.
- Unplug the Food Processor, then plug it back into the outlet.
- If the Food Processor is not at room temperature, wait until it reaches room temperature and retry.

Food Processor not shredding or slicing properly:

- Make sure the raised-blade side of the disc is positioned face up on the common adapter.
- If using the adjustable slicing blade, make sure it is set to the correct thickness.
- Make sure ingredients are suitable for slicing or shredding. See "Food Processing Tips"

If the work bowl cover won't close when using the disc:

- Make sure the disc is installed correctly, with the raised nub on top, and is positioned properly on the drive adapter.

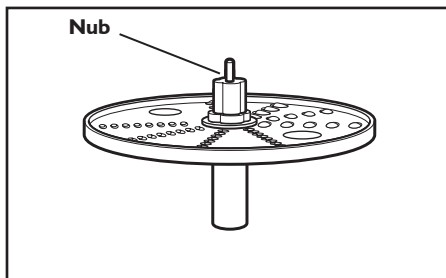

If the problem is not due to one of the above items, see "Warranty".

Do not return the Food Processor to the retailer. Retailers do not provide service.

Warranty

KitchenAid® Food Processor Warranty for the 50 United States, the District of Columbia, Puerto Rico, and Canada

This warranty extends to the purchaser and any succeeding owner for Food Processors operated in the 50 United States, the District of Columbia, Puerto Rico, and Canada.

Length of Warranty: One Year Full Warranty from date of purchase.

KitchenAid Will Pay for Your Choice of:



Hassle-Free Replacement of your Food Processor. See the next page for details on how to arrange for service, or call the Customer Satisfaction Center toll-free at **1-800-541-6390**.

OR

The replacement parts and repair labor costs to correct defects in materials and workmanship. Service must be provided by an Authorized KitchenAid Service Center.

KitchenAid Will Not Pay for:

- A.** Repairs when Food Processor is used in other than normal single family home use.
- B.** Damage resulting from accident, alteration, misuse or abuse.
- C.** Any shipping or handling costs to deliver your Food Processor to an Authorized Service Center.
- D.** Replacement parts or repair labor costs for Food Processors operated outside the 50 United States, District of Columbia, Puerto Rico, and Canada.

DISCLAIMER OF IMPLIED WARRANTIES; LIMITATION OF REMEDIES

IMPLIED WARRANTIES, INCLUDING TO THE EXTENT APPLICABLE WARRANTIES OF MERCHANTABILITY OR FITNESS FOR A PARTICULAR PURPOSE, ARE EXCLUDED TO THE EXTENT LEGALLY PERMISSIBLE. ANY IMPLIED WARRANTIES THAT MAY BE IMPOSED BY LAW ARE LIMITED TO ONE YEAR, OR THE SHORTEST PERIOD ALLOWED BY LAW. SOME STATES AND PROVINCES DO NOT ALLOW LIMITATIONS OR EXCLUSIONS ON HOW LONG AN IMPLIED WARRANTY OF MERCHANTABILITY OR FITNESS LASTS, SO THE ABOVE LIMITATIONS OR EXCLUSIONS MAY NOT APPLY TO YOU.

IF THIS PRODUCT FAILS TO WORK AS WARRANTED, CUSTOMER'S SOLE AND EXCLUSIVE REMEDY SHALL BE REPAIR OR REPLACEMENT ACCORDING TO THE TERMS OF THIS LIMITED WARRANTY. KITCHENAID AND KITCHENAID CANADA DO NOT ASSUME ANY RESPONSIBILITY FOR INCIDENTAL OR CONSEQUENTIAL DAMAGES. This warranty gives you specific legal rights and you may also have other rights which vary from state to state or province to province.

Hassle-Free Replacement Warranty – 50 United States, District of Columbia, and Puerto Rico

We're so confident the quality of our products meets the exacting standards of KitchenAid that, if your Food Processor should fail within the first year of ownership, KitchenAid will arrange to deliver an identical or comparable replacement to your door free of charge and arrange to have your original Food Processor returned to us. Your replacement unit will also be covered by our one year limited warranty. Please follow these instructions to receive this quality service.

If your Food Processor should fail within the first year of ownership, simply call our toll-

free Customer Satisfaction Center at **1-800-541-6390** Monday through Saturday. Please have your original sales receipt available when you call. Proof of purchase will be required to initiate the claim. Give the consultant your complete shipping address. (No P.O. Box numbers, please.)

When you receive your replacement Food Processor, use the carton and packing materials to pack up your original Food Processor. In the carton, include your name and address on a sheet of paper along with a copy of the proof of purchase (register receipt, credit card slip, etc.).

Hassle-Free Replacement Warranty – Canada

We're so confident the quality of our products meets the exacting standards of the KitchenAid® brand that, if your Food Processor should fail within the first year of ownership, KitchenAid Canada will replace your Food Processor with an identical or comparable replacement. Your replacement unit will also be covered by our one year limited warranty. Please follow these instructions to receive this quality service.

If your Food Processor should fail within the first year of ownership, take the Food Processor or ship collect to an Authorized KitchenAid Service Centre. In the carton

include your name and complete shipping address along with a copy of the proof of purchase (register receipt, credit card slip, etc.). Your replacement Food Processor will be returned prepaid and insured. If you are unable to obtain satisfactory service in this manner call our toll-free Customer Interaction Centre at **1-800-807-6777**.

Or write to us at:
Customer eXperience Centre
KitchenAid Canada
200 - 6750 Century Ave.
Mississauga, ON L5N 0B7

Arranging for Service after the Warranty Expires, or Ordering Accessories and Replacement Parts

In the United States and Puerto Rico:

For service information, , or to order accessories or replacement parts, call toll-free at **1-800-541-6390** or write to: Customer Satisfaction Center, KitchenAid Portable Appliances, P.O. Box 218, St. Joseph, MI 49085-0218

Outside the United States and Puerto Rico:

Consult your local KitchenAid dealer or the store where you purchased the Food Processor for information on how to obtain service.

For service information in Canada:

Call toll-free **1-800-807-6777**.

Or write to:
Customer eXperience Centre
KitchenAid Canada
200 - 6750 Century Ave.
Mississauga, ON L5N 0B7